

Solenoid directional valves type **DLEH** and **DLEHM**

poppet type leak free, direct operated, ISO 4401 size 06

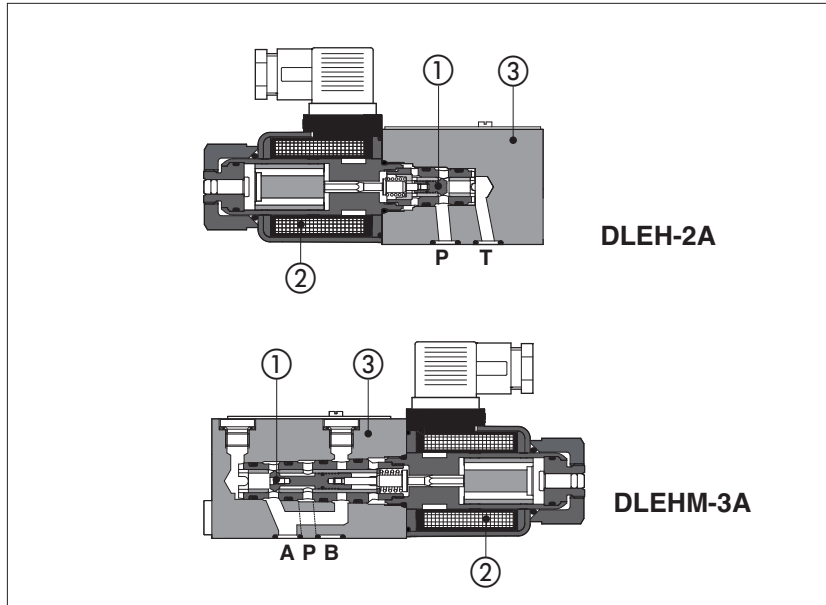

Poppet type ① direct operated valves, designed for applications in oil hydraulic systems with leak free requirements.

Following models are available in a wide range of configurations, see section ②

size 06 subplate version

- **DLEH**: two and three way execution, Q_{max} 12 l/min
- **DLEHM**: three way execution, Q_{max} 30 l/min

integral cartridge version for easy assembling in hydraulic blocks

- **CART LEH**: two and three way execution, Q_{max} 12 l/min
- **CART LEHM**: three way execution, Q_{max} 30 l/min

They are operated by wet type, screwed solenoids ② for DC or RC (rectified) current supply and certified according to the North American standard **cURus**

Standard coils protection **IP65**

Max flow: **12 l/min (DLEH, LEH)**
30 l/min (DLEHM, LEHM)

Max pressure: **350 bar (DLEH, LEH)**
315 bar (DLEHM, LEHM)

1 MODEL CODE

DLEH	-	2	/	A	/	WP	-	X	24 DC	**	/*
<p>Directional control valve poppet type:</p> <p>DLEH = ISO size 06, max flow: 12 l/min</p> <p>DLEHM = ISO size 06, max flow: 30 l/min</p> <p>CART LEH = cartridge version max flow 12 l/min</p> <p>CART LEHM = cartridge version max flow 30 l/min</p>											
<p>2 = two way (only DLEH and LEH)</p> <p>3 = three way</p>											
<p>Seals material, see section ③:</p> <p>- = NBR</p> <p>PE = FKM</p> <p>BT = HNBR</p>											
<p>Series number</p>											
<p>Voltage code, see section ④</p>											
<p>00-DC = DC solenoids without coils</p> <p>X = without connector</p> <p>See section ⑤ for available connectors, to be ordered separately</p>											
<p>Options, see section ④</p>											
<p>Valve configuration, see table ②</p>											

2 VALVE CONFIGURATION

<p>DLEH-2A CART LEH-2A</p>	<p>DLEH-2A/R</p>	<p>DLEH-2C CART LEH-2C</p>	<p>DLEH-2C/R</p>	<p>DLEHM-3A CART LEHM-3A</p>
<p>DLEH-3A CART LEH-3A</p>	<p>DLEH-3A/R</p>	<p>DLEH-3C CART LEH-3C</p>	<p>DLEH-3C/R</p>	<p>DLEHM-3C CART LEHM-3C</p>

3 MAIN CHARACTERISTICS, SEALS AND HYDRAULIC FLUIDS - for other fluids not included in below table, consult our technical office

Assembly position / location	Any position		
Subplate surface finishing	Roughness index Ra 0,4 - flatness ratio 0,01/100 (ISO 1101)		
MTTFd values according to EN ISO 13849	150 years, for further details see technical table P007		
Ambient temperature	Standard execution = -30°C ÷ +70°C /PE option = -20°C ÷ +70°C /BT option = -40°C ÷ +70°C		
Seals, recommended fluid temperature	NBR seals (standard) = -20°C ÷ +60°C, with HFC hydraulic fluids = -20°C ÷ +50°C FKM seals (/PE option) = -20°C ÷ +80°C HNBR seals (/BT option) = -40°C ÷ +60°C, with HFC hydraulic fluids = -40°C ÷ +50°C		
Recommended viscosity	15÷100 mm ² /s - max allowed range 2.8 ÷ 500 mm ² /s		
Fluid contamination class	ISO 4406 class 21/19/16 NAS 1638 class 10, in line filters of 25 µm (β ₂₅ ≥ 75 recommended)		
Hydraulic fluid	Suitable seals type	Classification	Ref. Standard
Mineral oils	NBR, FKM, HNBR	HL, HLP, HLPD, HVLP, HVLDP	DIN 51524
Flame resistant without water	FKM	HFDU, HFDR	ISO 12922
Flame resistant with water	NBR, HNBR	HFC	
Flow direction	As shown in the symbols of table 2		
Operating pressure	DLEH, LEH: Ports P, A, B 350 bar ; DLEHM, LEHM: Ports P, A 315 bar ; Port T 210 bar ;		
Rated flow	See diagrams Q/Δp at section 7		
Max flow	DLEH, LEH: 12 l/min , DLEHM, LEHM: 30 l/min , see operating limits at section 8		
Internal leakage	Less than 5 drops/min (≤ 0,36 cm ³ /min) at max working pressure		

3.1 Coils characteristics

Insulation class	H (180°C) for DC coils Due to the occurring surface temperatures of the solenoid coils, the European standards EN ISO 13732-1 and EN ISO 4413 must be taken into account
Protection degree to DIN EN 60529	IP 65 (with connectors 666, 667, 669 correctly assembled)
Relative duty factor	100%
Supply voltage and frequency	See electric feature 5
Supply voltage tolerance	± 10%
Certification	cURus North American Standard

4 NOTES

Options

WP = prolonged manual override protected by rubber cap

 The manual override operation can be possible only if the pressure at T port is lower than 50 bar

R = (only for DLEH) with check valve on P port, see section 2.

S = (only for DLEH and CART LEH) poppet with positive overlapping in the intermediate position to reduce the internal leakage at the valve switching and without manual override pin for safety applications (blind locking ring)

5 ELECTRIC CONNECTORS ACCORDING TO DIN 43650 (to be ordered separately)

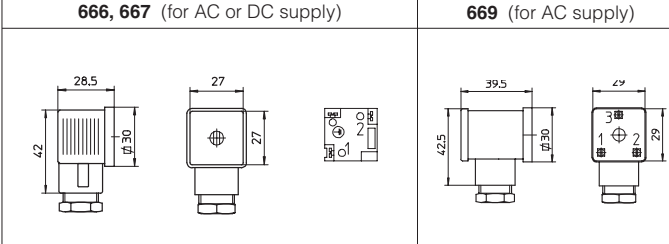
666, 667 (for AC or DC supply)	669 (for AC supply)	CONNECTOR WIRING		
		666, 667		669
		1 = Positive ⊕ 2 = Negative ⊖ ⊕ = Coil ground		1,2= Supply voltage Vac 3 = Coil ground
SUPPLY VOLTAGES				
666	667	669		
All voltages	24 AC or DC 110 AC or DC 220 AC or DC	110/50 AC 110/60 AC 230/50 AC 230/60 AC		

6 ELECTRIC FEATURES

External supply nominal voltage ± 10%	Voltage code	Type of connector	Power consumption	Code of spare coil
12 DC	12 DC	666 or 667	30 W	COE-12DC
14 DC	14 DC			COE-14DC
24 DC	24 DC			COE-24DC
28 DC	28 DC			COE-28DC
48 DC	48 DC			COE-48DC
110 DC	110 DC			COE-110DC
125 DC	125 DC			COE-125DC
220 DC	220 DC			COE-220DC
110/50 AC - 120/60 AC	110 RC	669		COE-110RC
230/50 AC - 230/60 AC	230 RC			COE-230RC

7 $\Delta p/Q$ DIAGRAM based on mineral oil ISO VG 46 at 50°C

Flow direction	P → A (1) (P → B)	A → T (B → T)
Valve type		
DLEH-2A	B	–
DLEH-2C	C	–
DLEH-3A	D	C
DLEH-3C	C	A
DLEHM-3A	F	E
DLEHM-3C	F	E

(1) For two-way valves, pressure drop refers to P→T

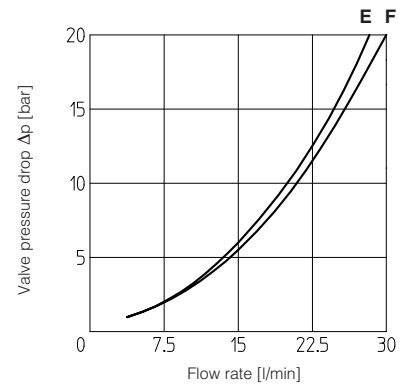
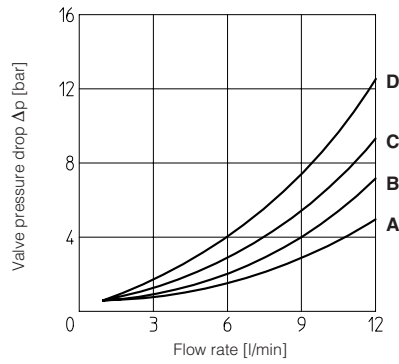

8 OPERATING LIMITS based on mineral oil ISO VG 46 at 50°C

The diagram has been obtained with warm solenoids and power supply at lowest value (Vnom - 10%).

A = DLEH-3A, DLEH-2C

B = DLEH-2A, DLEH-3C

C = DLEHM-3A

D = DLEHM-3C

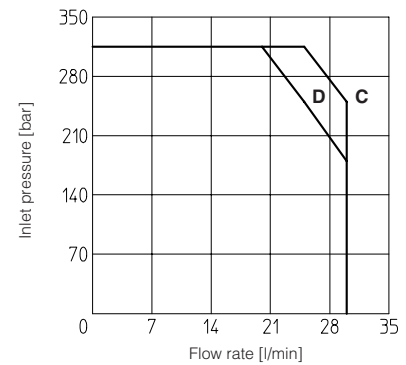
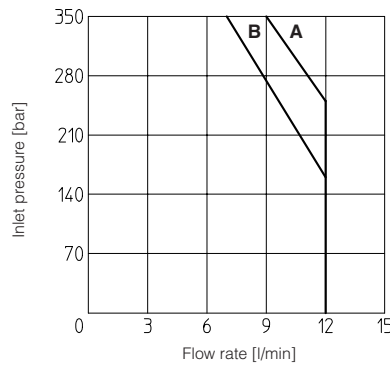

9 SWITCHING TIMES (average values in msec)

Valve type	Connector	Switch-on AC	Switch-on DC	Switch-off
DLEH(M)* DC	666, 667	–	45	25
DLEH(M)* RC	669	30	–	75

TEST CONDITIONS:

- 8 l/min; 150 bar
- nominal voltage
- 2 bar of counter pressure on port T
- based on mineral oil ISO VG 46 at 50°C

The response time is affected by elasticity of the hydraulic circuit, by variation of hydraulic characteristics and temperature

10 DIMENSIONS OF CARTRIDGE VERSIONS [mm] - for cavity dimensions see table P006

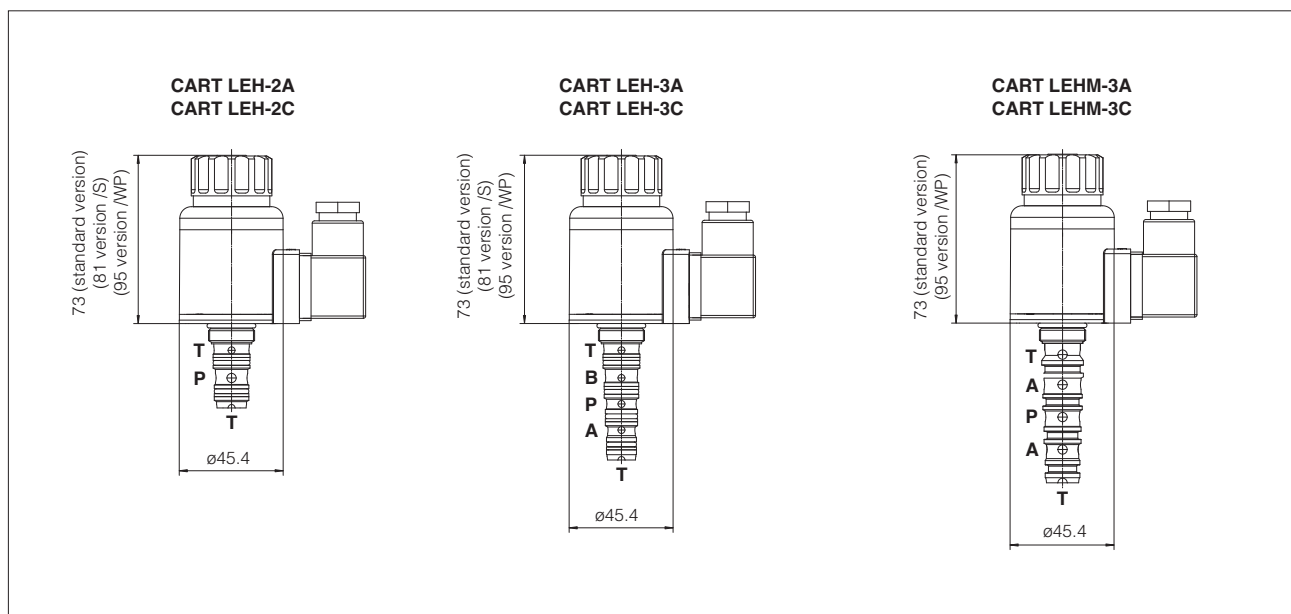

11 DIMENSIONS [mm]

**DLEH-2*
DLEH-2*/R**

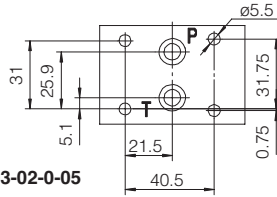

ISO 4401: 2005

Mounting surface: 4401-03-02-0-05
without A and B ports

Fastening bolts:
4 socket head screws M5x50 class 12.9
Tightening torque = 8 Nm
Seals: 2 OR 108
Ports P, T: Ø = 7,5 mm (max)

P = PRESSURE PORT
T = USE PORT

For the max pressures on ports, see section 3

**DLEH-3*
DLEH-3*/R
DLEHM-3*
DLEHM-3*/R**

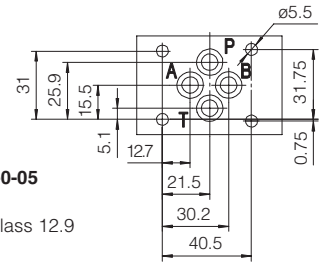

ISO 4401: 2005

Mounting surface: 4401-03-02-0-05

Fastening bolts:
4 socket head screws M5x50 class 12.9
Tightening torque = 8 Nm
Seals: 4 OR 108
Ports P, A, B, T: Ø = 7,5 mm (max)

P = PRESSURE PORT
A = USE PORT (not used for DLEH and LEH -3C versions)
B = USE PORT (not used for DLEH and LEH -3A versions)
T = TANK PORT

For the max pressures on ports, see section 3

**DLEH-2A, DLEH-2A/R
DLEH-2C, DLEH-2C/R**

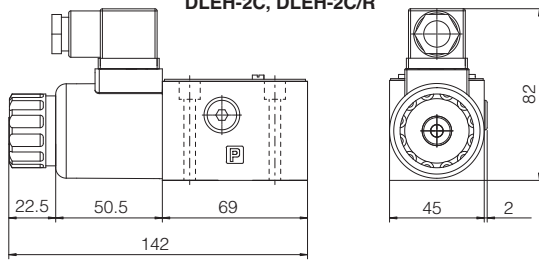

Mass: 1,5 Kg

**DLEH-3A, DLEH-3A/R
DLEH-3C, DLEH-3C/R**

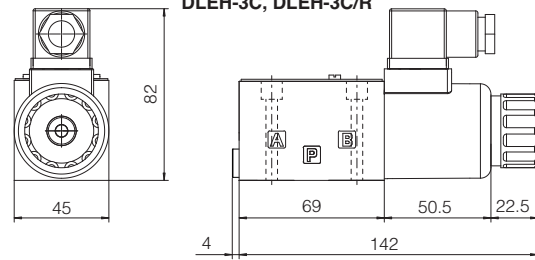

Mass: 1,5 Kg

DLEHM-3C

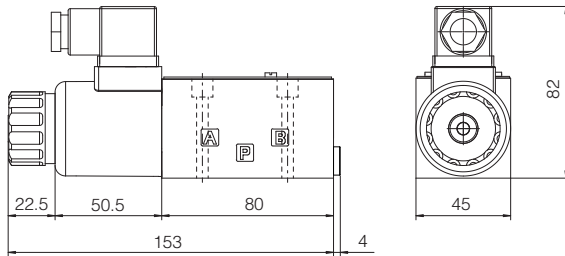

Mass: 1,7 Kg

DLEHM-3A

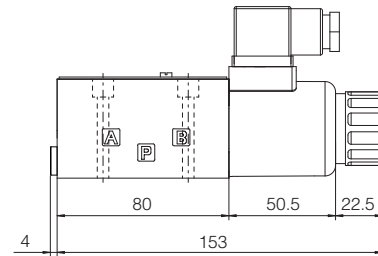

Mass: 1,7 Kg

Option /S

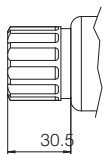

Option /WP

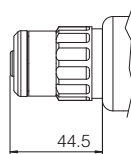

option /S = blind locking ring without manual override

option /WP = prolonged manual override, protected by rubber cap

Overall dimensions refer to valves with connectors type 666

12 MOUNTING SUBPLATES - see table K280

Valve	Subplate model	Ports location	GAS ports A-B-P-T	Ø Counterbore [mm] A-B-P-T	Mass [Kg]
DLEH-* DLEHM-*	BA-202	Ports A, B, P, T underneath;	3/8"	-	1,2
	BA-204	Ports P, T underneath; ports A, B on lateral side	3/8"	25,5	1,8
	BA-302	Ports A, B, P, T underneath;	1/2"	30	1,8